

# DV series

DV-20210 20 characters x 2 lines

## Mechanical Data

Item	Standard Value	Unit
Module Dimensions	180.0(W) X 40.0(H) X 9.50 (D)	mm
Viewing Area	149.0(W) X 23.0(H)	mm
Dot Size	1.12(W) X 1.12(H)	mm
Dot Pitch	1.22(W) X 1.22(H)	mm

## Absolute Maximum Ratings

Item	Symbol	Standard Value			Unit
		Min.	Typ.	Max.	
Supply Voltage for Logic	$V_{dd} - V_{ss}$	-0.3	--	7.0	V
Supply Voltage for LCD Drive	$V_{dd} - V_{ee}$	$V_{dd} - 13.5$	--	$V_{dd} + 0.3$	V
Input Voltage	$V_i$	-0.3	--	$V_{dd} + 0.3$	V
Operation Temperature	$T_{opr}$	0	--	50	°C
Storage Temperature	$T_{stg}$	-20	--	70	°C

## Electrical Characteristics

Item	Symbol	Condition	Standard Value			Unit
			Min.	Typ.	Max.	
Input "High" Voltage	$V_{IH}$		2.2	--	$V_{dd}$	V
Input "Low" Voltage	$V_{IL}$	$-I_{OH} = 0.205mA$	0	--	0.6	V
Output "High" Voltage	$V_{OH}$	$I_{OL} = 1.2mA$	2.4	--	$V_{dd}$	V
Output "Low" Voltage	$V_{OL}$		0	--	0.4	V
Supply Current	$I_{dd}$	$V_{dd} = 5V$	--	1.5	5.0	mA

## Pin Assignment

No.	Symbol	Function	No.	Symbol	Function
1	$V_{SS}$	GND,0V	9	DB2	Data Bus Line
2	$V_{DD}$	+5V	10	DB3	Data Bus Line
3	$V_{EE}$	For LCD Drive	11	DB4	Data Bus Line
4	RS	Function select	12	DB5	Data Bus Line
5	R/W	Read/Write	13	DB6	Data Bus Line
6	E	Enable signal	14	DB7	Data Bus Line
7	DB0	Data bus line	15	LED A	LED Power Supply
8	DB1	Data Bus Line	16	LED K	LED Power Supply

## Block Diagram

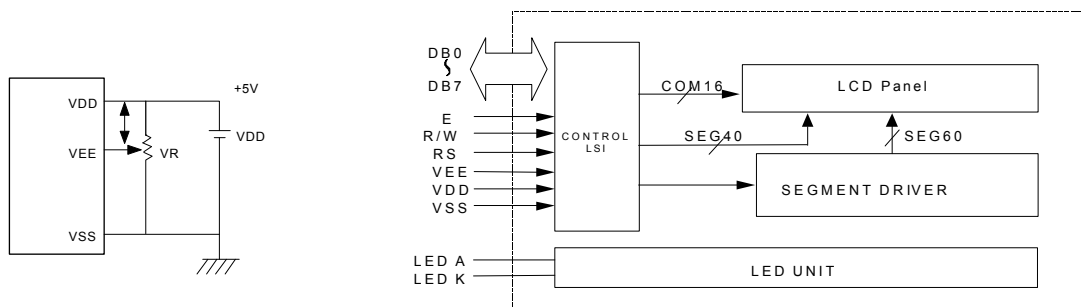

## External Dimensions

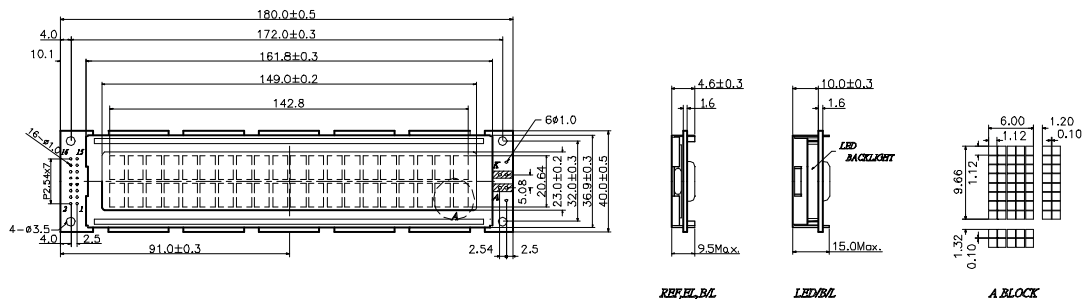

## Option

LCD Type								Backlight Type			Built-in Control LSI		
S1	S2	W	N	R	F	M	H	EL	LED	CCFL	Touch Panel		
•	•			•	•		•	•	•			KS-0066U or equivalent	

Remarks: S1 : yellow-green STN LCD , S2 : gray STN LCD , W : black & white LCD, N : negative type LCD, R : reflective type LCD, F : transfective type LCD, M : transmissive type LCD, H : extended temperature type LCD (-20 °C ~ 70 °C)

Tel.: +49 89 89979764

Fax: +49 89 89979765

Email: info@dst-gmbh.de

